















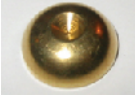

PART LIST

12		Long bolt with washer
4		Black short bolt with washer
4		Brass smart spike
4		Rubber tipped pin
4		Vinyl glide feet
4		Brass carpet spike
4		Gold "C" connector
1		Metal door handle with screws
2		Foam rubber bumper
4		Brass cap
1		Small allen wrench
1		Large allen wrench
4		Back panel spacer
1		Wrench for smart spikes
2		Black plastic cap
4		Round locking cams
4		Threaded locking pins
4		Round legs

Step 1

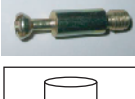
Start assembly with the top shelf of the rack upside down. Use care not to scratch the surface of this wood shelf during this step. Carpet or other soft surfaces work best for this.

The curved front of the top should be facing you during steps on page 1, 2 and 3.

Secure the two end panels to the top shelf as shown here. Use the pins and cams provided as shown. The pins simply screw into the threaded inserts in underside of the top shelf.

Now is the time to decide which way you want the door to open. Install the side panel with the hinge plates on the side you want the door to open from.

The hinge plates should be facing the front/inside of one of the panels at this point. Make sure that the opposite panel is installed in the same orientation even though it does not have hinge plates on it.

Then slip the end panels over the pins and lock the cam in place clockwise with a screwdriver. If the round locking cams are not pre-installed in the side and middle panels, push them in the holes as shown here with the screwdriver slots facing out.

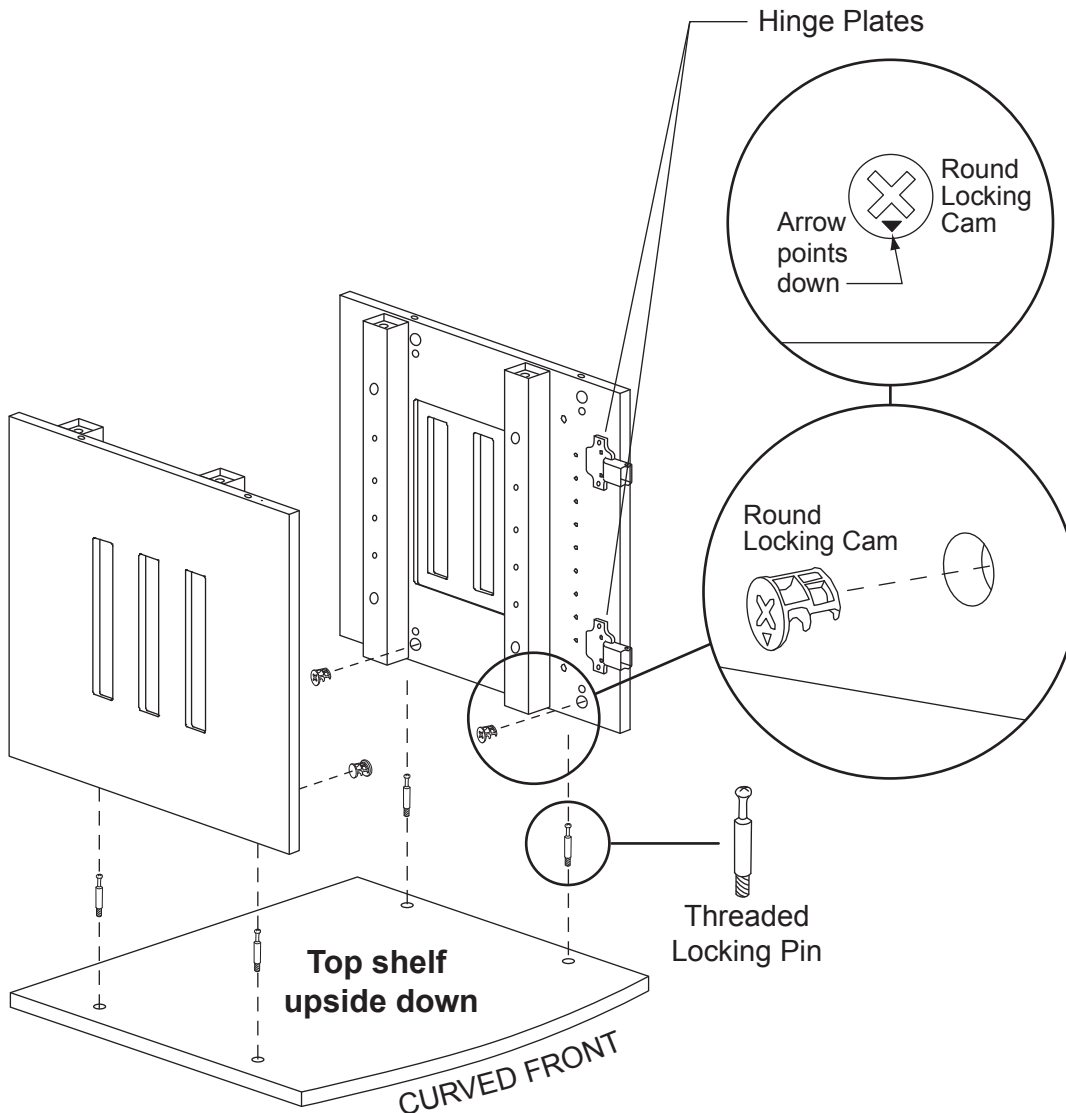

The small arrow stamped in the face of the cam should be facing down as shown in here during assembly. Once the panel is located over the locking pin, tighten the locking cam with a screwdriver in clockwise direction. Be sure the cam is tight and the panel is securely fastened in place.

Step 2

***** SELECT **(A)** OR **(B)** FOR THIS STEP *****

(A) Carpet Spikes or Vinyl Glide Feet

Be certain that the curved front edge of this wood shelf faces forward (the same direction as the bottom shelf) with the good finished side facing down (inside of the cabinet). Next secure the bottom wood shelf with 4 long bolts with washers into the metal pillars. Then attach the 4 metal round legs to the underside of the cabinet as shown below. The round feet bolt to the bottom shelf with one long bolt and washer per leg through the topside (underside for this step) of the wood shelf as shown in the illustration.

Be careful during this step not to scratch the top and bottom shelves with the side panels.

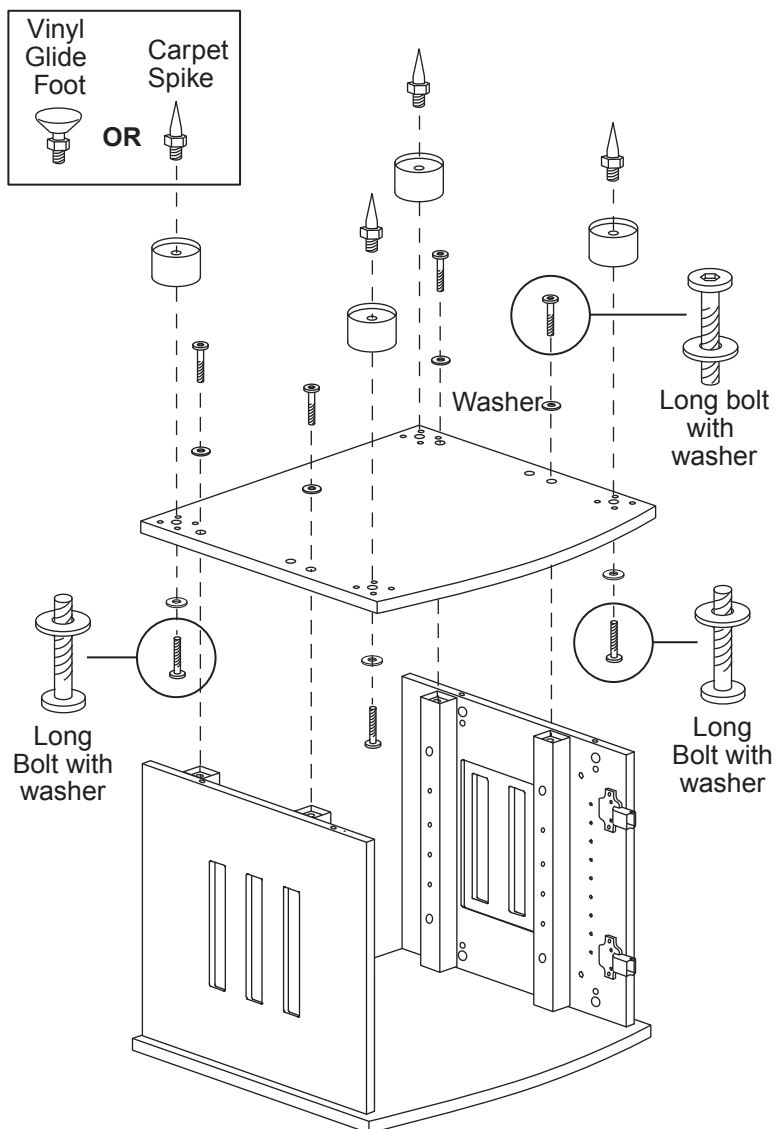

(B) Optional Rolling Casters

If optional rolling casters are used. Be certain that the curved top shelf of this wood shelf face forward (the same direction as the bottom shelf) with the good finished side facing down (inside of the cabinet). Next secure the bottom wood shelf with 4 long bolts with washers as shown here. Then install the Optional rolling casters with 4 screws (provided) per caster as shown.

Be careful during this step not to scratch the top and bottom shelves with the side panels.

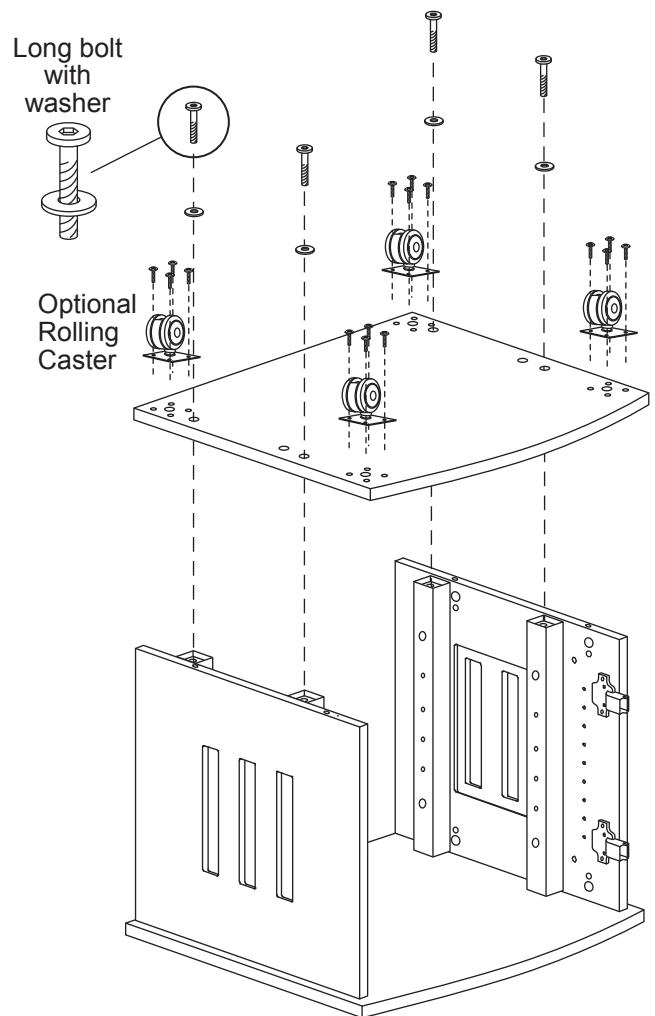

Step 3

You are now ready to install the door and put the interior shelves in the rack. To install the shelves, you have a choice of using rubber tipped steel shelf pins or adjustable smart shelf pins. The smart spikes are provided for added sonic isolation for each shelf (see illustration C1).

The last step is to install the door. Secure the door with the hinges on the cabinet by aligning the front part of the hinge with the hooks on the front of the hinge plate (see illustration A, B, C and D).

Once these small hooks are locked in the front of the hinge, push the black tab upward or downward and press firmly on the back part of the hinge until it clicks in place. If the door is mounted on the left side panel, PUSH the black tap upward. If the door is mounted on the right side panel, PUSH the black tap downward (see illustration B). You must push the black tab firmly during this step while pushing the hinge onto the hinge plate. Once the hinge is firmly pressed onto the hinge plate, release the black tab and ensure that the hinge is firmly locked onto the hinge plate with the black tab locking mechanism.

If you need to remove a door simply press/move the small black tab on the back on the hinge plate up or down (see illustration C1). This will unlock the hinge and allow the door to be removed. Use caution during this step. The doors are heavy and should be handled with care.

NOTE: BE VERY CAREFUL WHEN INSTALLING AND ADJUSTING THE DOOR NOT TO SCRATCH THE FRONT EDGE OF THE BOTTOM SHELF WITH THE DOOR.

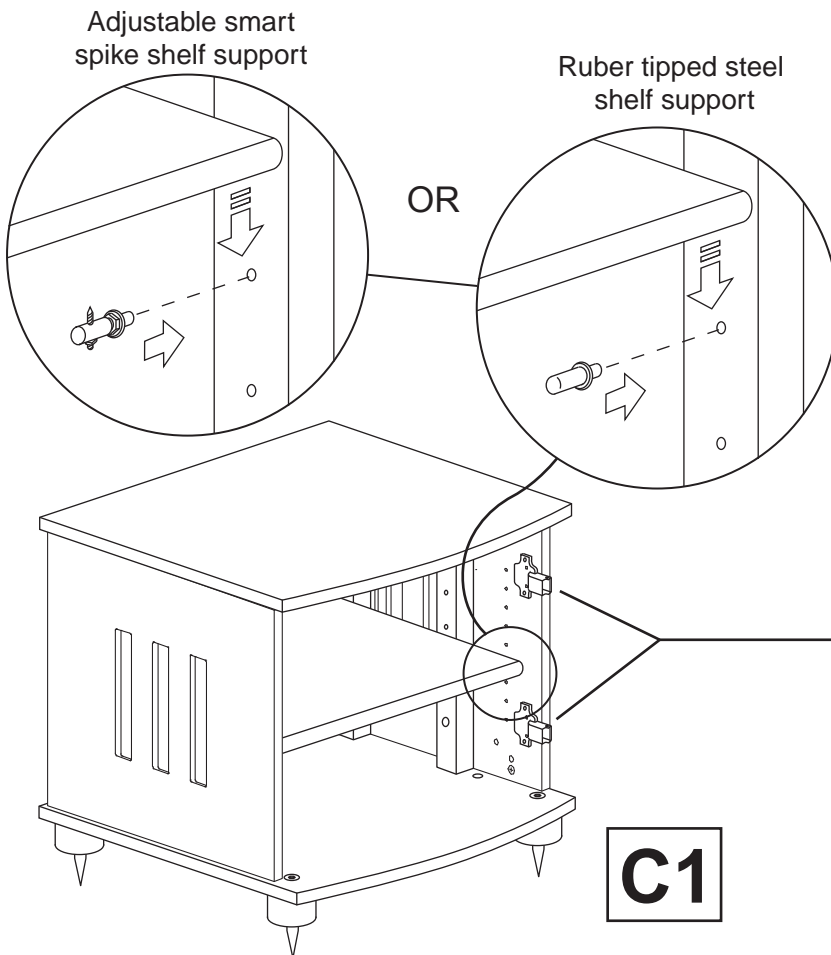
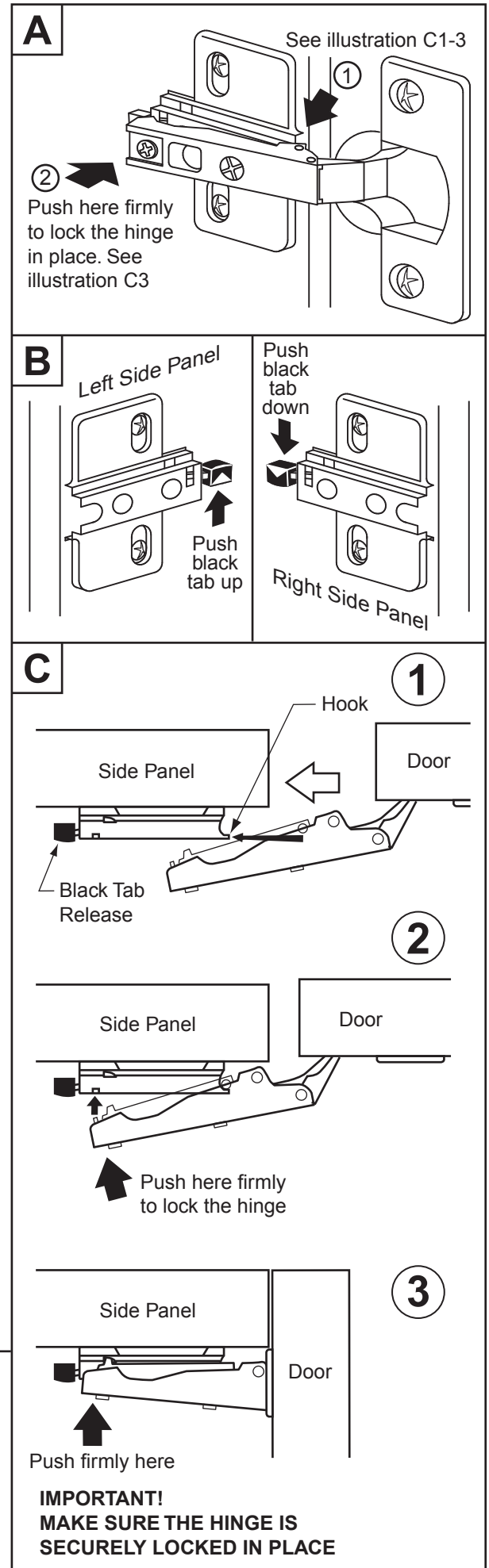

Step 4

NOTE: THE DOOR MAY NEED SLIGHT ADJUSTMENT TO FIT PROPERLY IN THE OPENING OF THE CABINET, YOU MAY NEED TO ADJUST THE HINGES SIDE TO SIDE, IN OR OUT, UP OR DOWN (SEE ILLUSTRATION E1-3).

The final step for the doors is to attach the door handles. They simply screw to the doors with two screws each through the back of each door as shown.

D

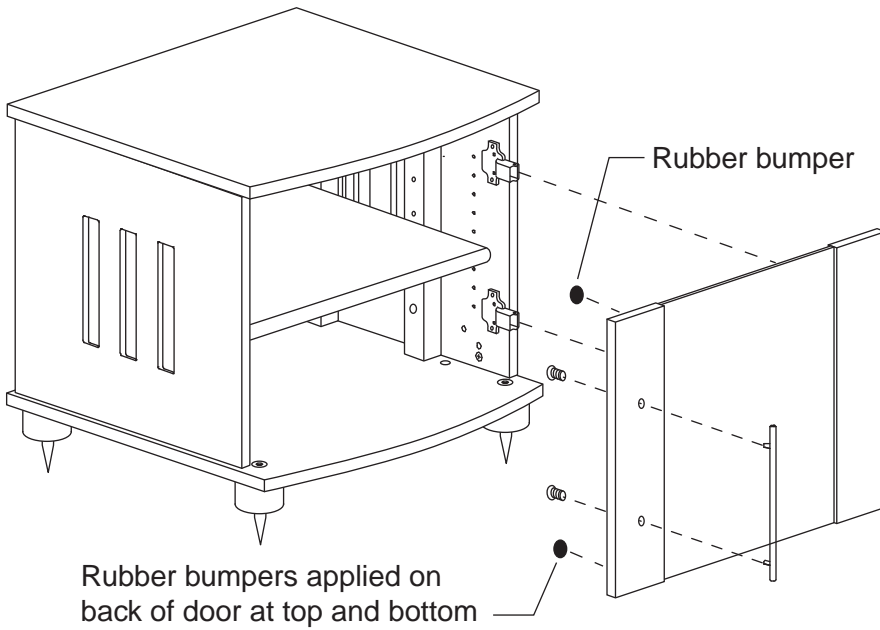

To adjust the door, see hinge details below.
 To adjust door side to side, see detail #1.
 To adjust door in and out, see detail #2.
 To adjust door up and down, see detail #3.

DOOR HINGE ADJUSTMENT

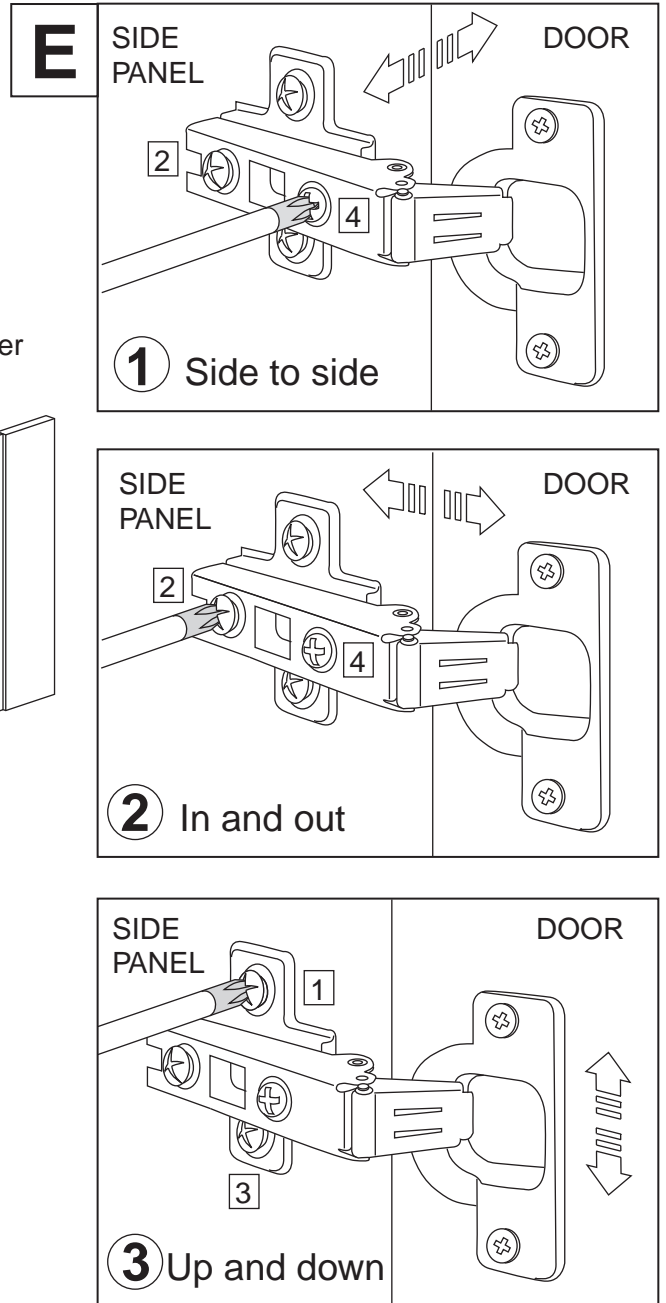

Step 6

Secure the outer frame to the back of the cabinet with the black short bolts and the longer extension tubes provided as shown here. Be sure the velcro is facing out for this step.

Finally attach the panel covers over the outer frame by pressing the outer panel over the opening. Velcro attachments have been applied to the back panel for this.

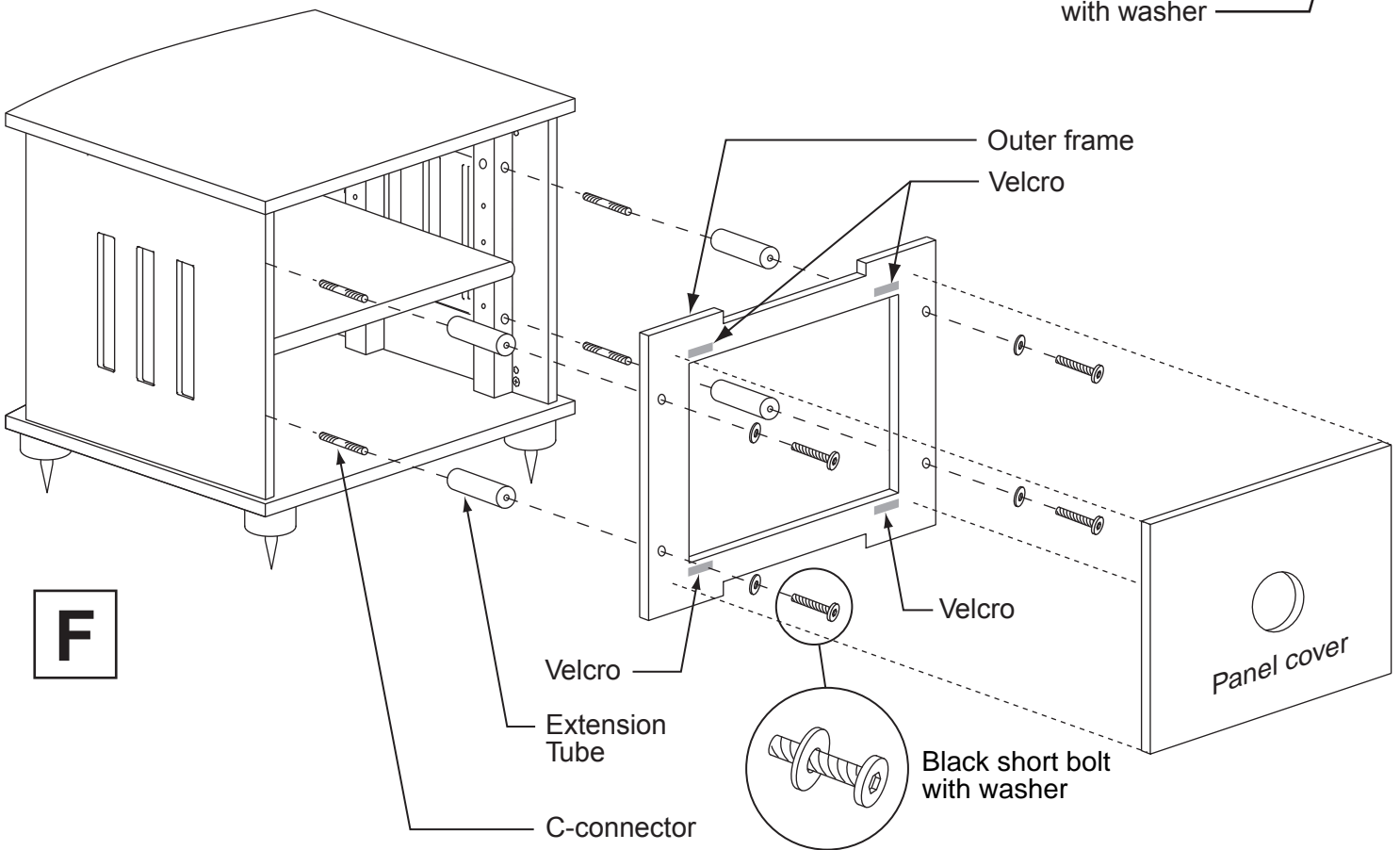
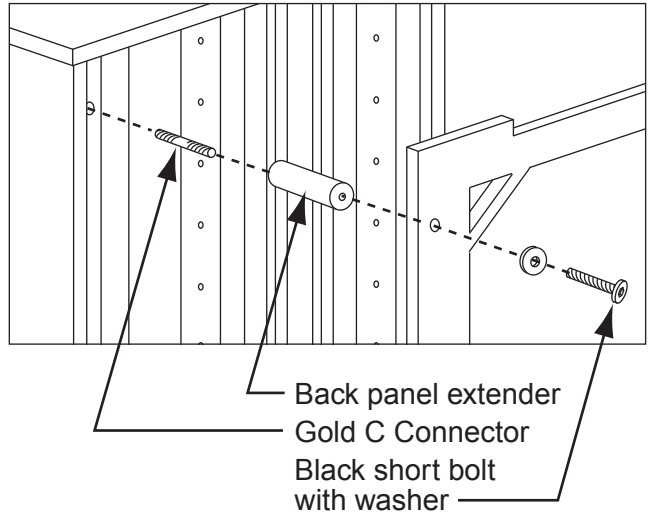

Limited Lifetime Warranty

Thank you for choosing StudioTech product.

StudioTech is a premier Audio/Video Furniture manufacturer and we offer a full line of Audio/Video Furniture. The product you have just purchased has been designed and manufactured with great care and attention to detail. We are pleased to offer you a Limited Lifetime Warranty on this product as outlined below.

Lifetime Warranty

StudioTech Inc., warrants to the original retail purchaser, that this product is to be free from defective materials and workmanship, when used in normal applications, for the life of the product. StudioTech warrants that it will repair or replace, at its option, any such defective product at no charge for parts or labor provided the product is delivered intact by the owner, postage prepaid to StudioTech. Inspection must disclose that all defects are as specified. If we repair this product, we may use new or remanufactured replacement parts. If we choose to replace this product, we may replace it with a new or remanufactured product of the same or similar design. If you are not registered in our Customer Care Program, Proof of Purchase is required. This Limited Warranty extends only to the original first retail purchaser of the product and is not assignable or transferable to any subsequent purchaser/end-user. No StudioTech dealer, agent, or employee is authorized to make any modification, extension, or addition to this warranty.

Limitations:

THIS WARRANTY AND REMEDIES SET FORTH HEREIN ARE EXCLUSIVE AND IN LIEU OF ALL OTHER WARRANTIES, REMEDIES AND CONDITIONS, WHETHER ORAL OR WRITTEN, EXPRESS OR IMPLIED. This warranty is limited to this StudioTech product and specifically excludes consequential damages to other components or premises which may result for any reason from the failure of the product. This warranty is null and void for products not used in accordance with StudioTech's instructions and shall also be null and void for products misused, neglected, abused, modified, altered or damaged by accident or otherwise not in accordance with StudioTech's instructions. This warranty does not cover cosmetic damage including paint damage by accidental or normal wear during use.

StudioTech assumes no liability for any costs or fees incurred for any services performed where nothing is wrong with the product, nor does StudioTech cover the cost of set up, installation, or adjustment. This warranty does not cover time, transportation or compensate for inconvenience or loss of the product. In no event shall StudioTech be liable,

whether in contract or tort (including negligence) for damages in excess of the purchase price of the product, or for any indirect, incidental, special or consequential damages of any kind, or loss of revenue or profits, loss of business, loss of information or data, or other financial loss arising out of or in connection with the ability or inability to use the product, to the full extent these damages may be disclaimed by law.

This warranty gives you specific legal rights, and you may also have other rights that vary by state or province. STUDIOTECH SPECIFICALLY DISCLAIMS ANY AND ALL IMPLIED WARRANTIES, INCLUDING, WITHOUT LIMITATION, WARRANTIES OF MERCHANTABILITY AND FITNESS FOR A PARTICULAR PURPOSE, OR OTHERWISE. STUDIOTECH, INC. SHALL IN NO CASE BE RESPONSIBLE FOR INCIDENTAL OR CONSEQUENTIAL DAMAGES OTHER THAN SET FORTH ABOVE. Some states do not allow limitations on how long a warranty applies and/or exclusions or limitations of incidental or consequential damages, so the above limitations may not apply to you.

Returns:

In the event you believe this StudioTech product may be defective in the course of the warranty period, you must contact StudioTech to receive Return Authorization. We will either ship you a replacement part for your product or we will issue an RA for you to return the product to us. Once you have received Return Authorization, you are responsible for delivery of product with a copy of the completed return authorization form and the original Bill of Sale, postage prepaid to StudioTech for repair or replacement. Remember to pack all parts carefully and in the original carton if possible and mark the RA # clearly on the outside of the carton near the address label. We suggest you insure the package as StudioTech is not responsible for loss or damage caused in shipment while product is in transit to StudioTech or by improper packaging. Additional charges may be added to product which requires new packaging materials for return shipment. No returns will be accepted without proper Return Authorization from StudioTech. This authorization may not be given by any other party. Unauthorized returns will be refused and the purchaser will be liable for shipping charges in both directions. Repaired product will be shipped back to you postage prepaid within the continental U.S.A. StudioTech reserves the right to make changes in warranty, product design, and specifications at any time.

Thank you again for purchasing StudioTech products.